

Name: \_\_\_\_\_

Period: \_\_\_\_\_

### Checkpoint 6D

*Integrated Math 2*

Answer the questions thoroughly including any necessary math or explanations.

Calculate the base area and volume of the figure. Circle both values.

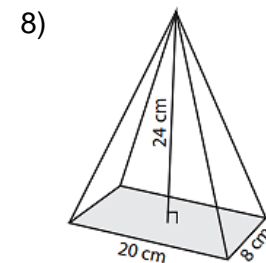
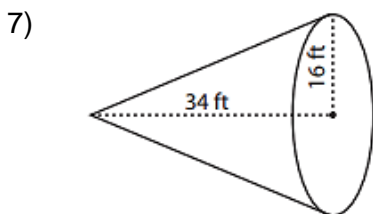
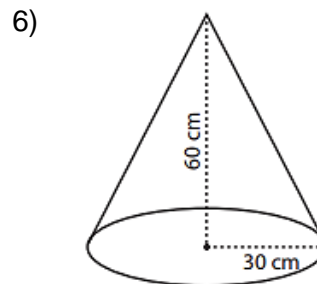
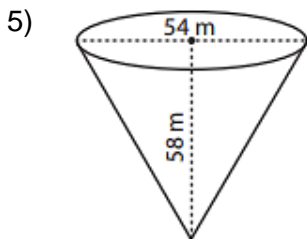
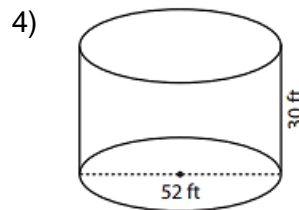
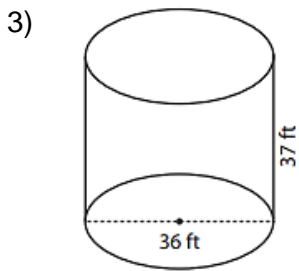
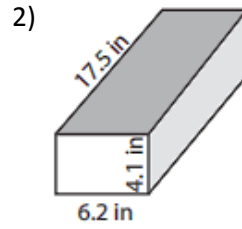
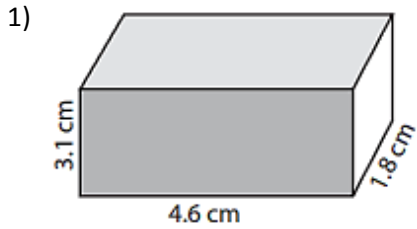

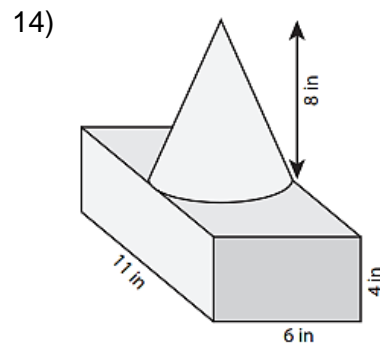
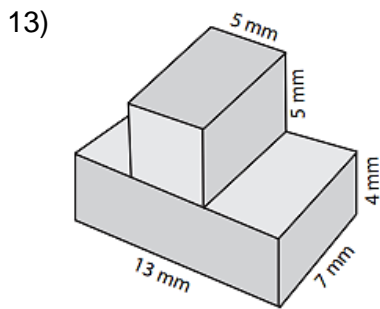
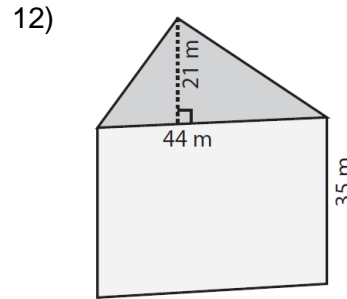
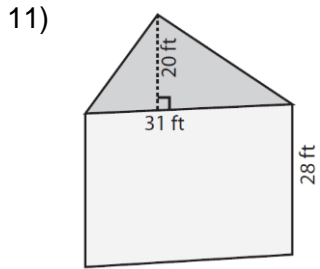
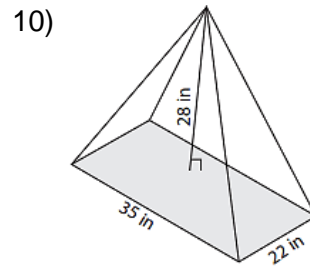
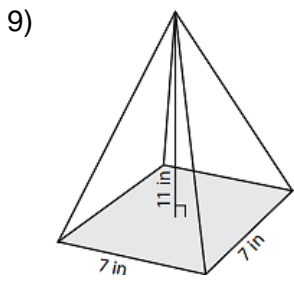

- 15) A rectangular prism is removed from another prism. How much volume of the prism is left? Round your answer to the nearest hundredth.

